

Article number: 209925D25M8

Description: E+G Threaded end-caps - GN 992.5-D25-M8

## Measures

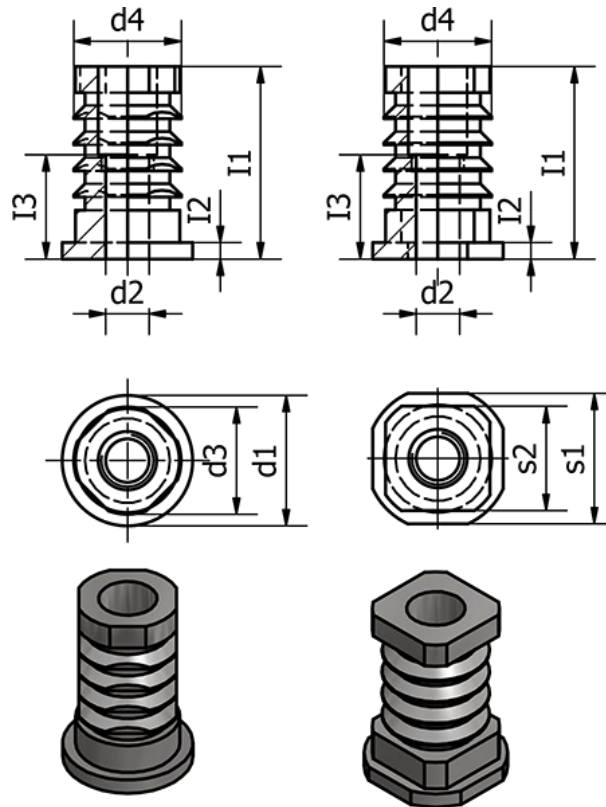

d1 = 25

d2 = M8

d3 = 21

d4 = 29.5

I1 = 33.5

I2 = 2.5

I3 = 16

s1 =

s2 =

Weight (g) = 53